

**CT1**  
PROCARGO

**Sortimo**<sup>®</sup>  
Intelligent Mobility

# ProCargo CT1

*The lightest and most environmentally friendly commercial vehicle!*

Intelligent **Mobility**  
for urban **transport**

innovative  
**tilting technology**

wide variety  
of **add-on systems**



flexible **loading platform**  
with **ProSafe** load securing



# ProCargo CT1

*The new dimension of transportation*



## *Independent and quick*

The ProCargo CT1 has catapulted Sortimo to a **new dimension of transportation and mobility**. Urbanisation necessitates to provide for even more services in urban areas in future and to transport goods preferably emission free to their destination without particle pollution. The logical consequence of this is switching to alternative drive systems and even to other innovative means of transport.

The ProCargo CT1 not only characterises itself in the urban areas but also in factory traffic by its brilliant cornering ability made possible by its patented tilting technology and the **unique integration of load securing**.

With the ProCargo CT1 Sortimo enables all service technicians, delivery services, bicycle couriers, municipalities and everyone involved in factory traffic, **a fast and healthy transportation option without having to worry about traffic jams and licenses**.

## *ProCargo CT1 - the perfect extension to your business fleet*

Implement the ProCargo CT1 as an extension to your existing business fleet. Especially in the areas logistics, parcel and mail delivery and express services, the star shaped organisational form for hub-and-spoke-systems is already established. Sortimo is the ideal partner here, because we offer you **the right load securing and equipment concepts for your transporters from the warehouses to the hubs** and ultimately facilitate the **fast distribution to the recipients with the cargo bikes**.

But also a flexible transport solution is becoming more important in urban environments for the services and skilled trades in order to go the last mile. It is good when you have the possibility to changeover.

*"An **innovative solution** for the highest demands."*

ProCargo CT1 is also the ideal means of transport for factory traffic and for the delivery of interoffice mail.

*"We have been searching for a future-orientated approach to mobility in large power plants like those of network providers for example and are happy that with the cargo cycle ProCargo CT1 by Sortimo we have found an innovative solution which meets our demands.*

*These concern the transportation possibility of tools on the one hand, but on the other hand also the high safety standards that we must comply with in the company traffic."*

Patrick Lausch,  
Security division manager for the ISS VSG GmbH

# ProCargo CT1

The new dimension of transportation

## Technical data

<b>Engine:</b>	Bosch Performance Line Cruise CX 25 km/h	<b>Lighting system:</b>	Supernova E3
<b>Battery:</b>	Bosch PowerPack 500 Wh rechargeable battery attached to frame	<b>Handle bars:</b>	Satori Noir 31.8 x 630 mm 15° backsweep
<b>Battery recharger:</b>	Standard Charger 4 A (220 - 240 V)	<b>Handle bars stem:</b>	Satori Compact 2, 31.8 mm, 95 mm, adjustable angle
<b>Display:</b>	Bosch Purion Bordcomputer	<b>Tyres front / rear:</b>	Schwalbe Big Ben Plus 55-406 / Super Moto X 62-584
<b>Drive system:</b>	Gates Carbon Drive CDX 111T	<b>Mudguard / Carrier:</b>	Tubus Wingee
<b>Brake system:</b>	Tektro Auriga Twin Ø 180 mm (front) Tektro Auriga Tune Ø 180 mm (rear)	<b>Max. speed:</b>	Engine support of up to 25 km/h, no driver's licence required
<b>Gear system:</b>	NuVinci N380 SE Hub with Harmony H8 rotary handle	<b>Weight / payload:</b>	48 kg / 240 kg (100 kg Driver's weight+ 140 kg payload)
<b>Pedal:</b>	VP Pedal VP-658	<b>Colour:</b>	Matt black
<b>Saddle:</b>	Shadow GEL		

The ProCargo CT1 is available in 2 lengths:

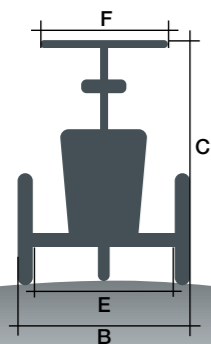

	Dimensions	ProCargo CT1 L2	ProCargo CT1 L3
A	Total length	2548 mm	2786 mm
B	Total width	785 mm	
C	Height	1200 - 1400 mm (depends on handle bars)	
D	Length of loading platform	690 mm	928 mm
E	Width of loading platform	660 mm	
F	Handle bar width	640 mm	
G	Wheel base	1919 mm	2157 mm

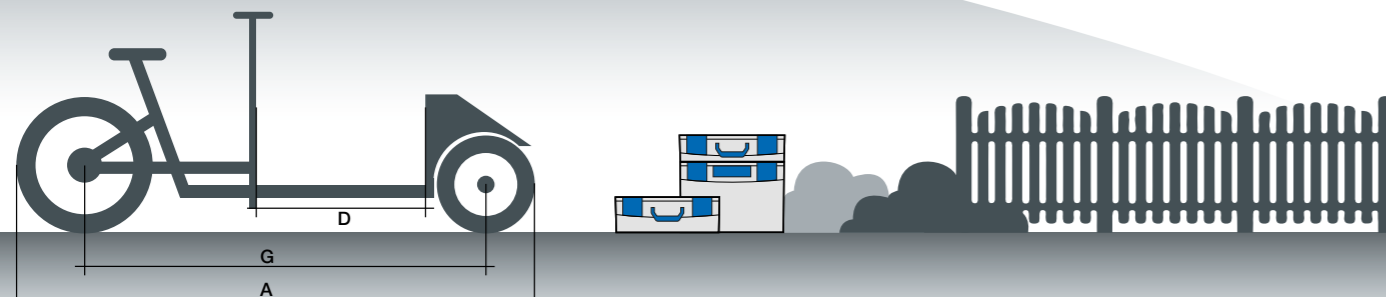

The ProCargo CT1 unifies the benefits of...

Pedelec	Cargo cycle	Trike
<ul style="list-style-type: none"> <li>no registration required</li> <li>no driver's licence required</li> <li>unlimited parking possibilities</li> <li>support by means of electric engine</li> <li>no parking ticket possible</li> </ul>	<ul style="list-style-type: none"> <li>unlimited application possibilities</li> <li>saves time compared to motor vehicles</li> <li>unbeatable price-performance-ratio</li> <li>fit staff</li> <li>positive ecological balance</li> <li>image enhancement for the company</li> </ul>	<ul style="list-style-type: none"> <li>Safe driving handling in any season</li> <li>stable even without a bicycle stand</li> <li>steady even at reduced speed</li> <li>trouble-free start-up</li> <li>high bearing load</li> </ul>

# ProCargo CT1

## Professional load securing

- universal loading platform incl. proven **ProSafe system**
- quick and easy loading **saves time**
- functional transport and add-on solutions** with the storage volume of the boot of a compact car

## Reach customers quickly

- patented **2-level tilting technology**
- executes tightest turning circle** and **agile driving handling** through narrowest of streets, past traffic jams
- narrow track width**, smooth negotiation through barriers in pedestrian zones or on bicycle paths

## Safety for you

- Stability**
- Steadfastness**
- secure driving experience** by means of 3 wheels

## Low emission zone – poses no obstacle

- no particle pollution**, completely **emission free**
- Well prepared for the future **and independent of political decisions.**



## Cost saving

- no fuel costs** (the electricity cost factor is negligible)
- low insurance costs**
- little space required** and **less costs for parking spaces** as well as
- low fixed** and **maintenance costs**

## Being perfectly happy

We enable individual solutions for all your requirements by means of our experienced project management staff.

# ProCargo CT1

## Components



highest quality belt drive



Hydraulic disc brake system



Practical Frontbox



ProSafe loading platform



High quality stem



Bosch electric engine

*This combination of a cargo cycle and a load securing concept is absolutely unique on the market!*

In contrast to most cargo bikes the common chain has been replaced in the ProCargo CT1 by a future orientated **Gates Carbon Drive CDX belt drive**. The significant benefits for you include **substantially longer durability** and the **quiet and maintenance free functionality with absolutely guaranteed rust resistance**.

The hydraulic **Tektro Auriga Twin disc brake system** (Ø 180 mm) has brake pads made of high performance metal with a ceramic compound and guarantees you **easy regulation with good heat resistance and high braking performance**. The locking brake function enables **secure parking in every situation** by means of a locking mechanism.

The ProCargo CT1 has a weather-proof and lockable **Frontbox**, in which you can stow away practical accessories conveniently and safely such as e.g. a bicycle helmet, an L-BOXX Mini with breakdown kit, a high visibility jacket, a warning light, or a second rechargeable battery. As a result you **have all important objects with you** when needed and can leave everything in the cargo cycle without worry, when parked, due to the lock function.

The **loading platform** is made of hard-wearing ABS hard plastic and is closed off on both sides using aluminium rails with an integrated ProSafe lashing system. Thus enabling a **professional load securing** via the proven Sortimo Pro-Safe System using e.g. lashing straps, CargoStopp ProSafe, load securing nets and many others.

The high quality forged **aluminium stem Satori Compact 2** provides for individual handle bar adjustment and thus enabling different seating positions for a multitude of driver sizes. The height of the handle bar can be extended by up to 11.5 cm by means of an angle change of the solid and durable stem (max. angle 60°) and provides for an **ergonomic driving comfort for all body sizes**.

With the concentrated energy of the **electric engine Performance Line Cruise CX** from the leading international leading eBike engine manufacturer Bosch, pedalling is strongly supported with a speed of up to 25 km/h and enables a **sporty driving style on both flat and steep terrain**. Consequently you neither require a driver's licence, nor a registration.



Bosch Power Packs 500



Nuvinci gear system



Supernova head lights



Unique tilting technology



Functional Bosch Display



Frame lock for securing

When it comes to the innovative **Bosch Powerpacks 500** we are talking about a lithium-ion-battery with 500 Wh energy budget. The rechargeable battery is directly attached to the frame **facilitating installation and removal and the battery can be directly recharged on the bicycle**. The range reaches 40 to 60 km depending on the payload and selected engine support and is fully recharged in 4.5 hours with the Bosch Standard Charger.

The **NuVinci Harmony N380 SE gear hub** enables an fully automatic gear change. When the automatic mode is on, the system monitors the pedal rotations as well as the speed of the bike and as a result **the pedal frequency remains constant during the entire journey**. When the manual mode is on, you individually determine the gear transmission which correlates closely with the functionality of a conventional gear change.

The **Supernova E3 E-Bike V521s head lights** with a water-proof aluminium casing provide outstanding illumination in the dark. The entire aluminium casing is CNC-milled salt-water proof anodised, 100% water-proof, secured against theft and well prepared for the hardest eBike day-to-day work. Consequently you always have a far and widely illuminated road in front of **you even on the darkest of roads** with a **pleasurable driving experience**.

Thanks to the **patented tilting technology** the ProCargo CT1 provides stability that is in a class of its own. Whether in an urban environment, on the bicycle paths or on factory premises the tilting technology of the ProCargo CT1 provides you with **maximum stability** and an **entirely new driving pleasure**. Fast cornering, even when fully loaded, is thereby possible.

The compact **Display Bosch Purion** shows you the current speed, the battery status and the selected support levels via the standard display. The most important driving data such as total kilometers, range and distance can be accessed quickly and conveniently by means of the double assignment of both plus and minus buttons. **Consequently you have direct access to all the important information**.

The **frame lock Abus Shield 5650** is the base locking device for the ProCargo CT1. The serial production attached frame lock with a 8.5 mm thick locking clip is a **practical and easy to use protection aid against unauthorised access**. The clip, the casing as well as the supporting components of the locking mechanism are all manufactured from special hardened steel.

# ProCargo CT1

## Add-on solutions

The **Cargo-Unit** is a closed and weather-proof add-on solution specifically developed for the ProCargo CT1, which is available in different lengths and configurations. The **theft-proof installation** is carried out inside the Cargo-Unit using four screw fittings on the ProSafe rail of the loading platform.

The Cargo-Unit is the ideal transport or as the case may be organisational solution for the ProCargo CT1 depending on the configuration, in which goods, parcels and tools can be safely stowed away at any time. The Cargo-Unit is available in a variety of configurations for both wheel bases of the ProCargo CT1. All configurations are equipped with a lockable cover which opens from the top.

The reference names have the abbreviations integrated into the different configurations, e.g. "TL" = Top-Loader or as the case may be "STL" = Side-TopLoader.

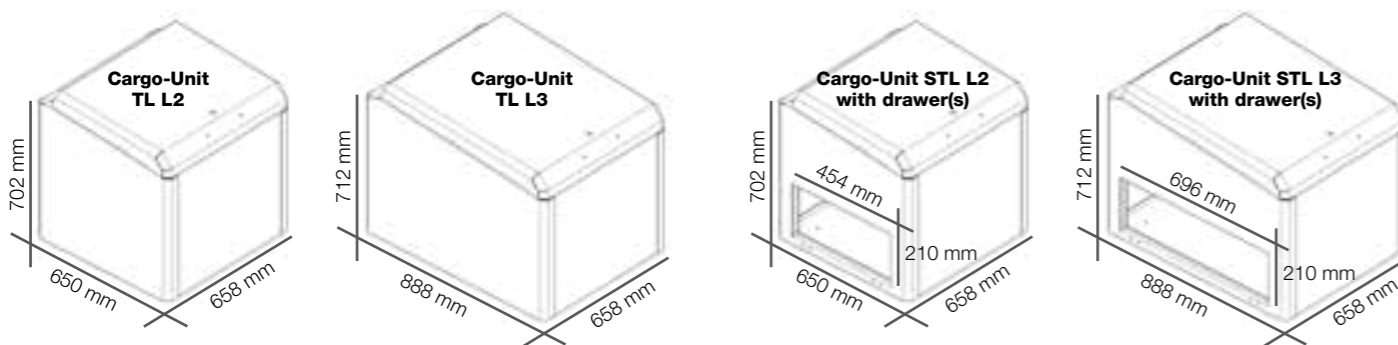

## Cargo-Unit TopLoader



**Holding capacity** is comparable with the luggage space volume of a compact category passenger vehicle.

The Cargo-Unit TopLoader has an **enormous holding capacity with a very low net weight**. Consequently the **permissible total weight** of the ProCargo CT1 is hardly affected and can be **utilised to the last**. The virtually vertical opening of the cover enables very convenient loading and unloading.

**CARGO-UNIT TL L2**  
Ref. No. 1000010318  
Colour: Black  
Material: Aluminium  
Weight: 16.6 kg  
Holding capacity: 268.39 l  
Dimensions (LxWxH): 650 x 658 x 702 mm  
**950.00 €**

**CARGO-UNIT TL L3**  
Ref. No. 1000010319  
Colour: Black  
Material: Aluminium  
Weight: 20.5 kg  
Holding capacity: 369.75 l  
Dimensions (LxWxH): 888 x 658 x 712 mm  
**980.00 €**

## Cargo-Unit SideTopLoader with drawer(s)

**CARGO-UNIT STL L2 WITH 2 DRAWERS**  
Ref. No. 1000010368  
Colour: Black  
Material: Aluminium  
Weight: 32.5 kg  
Holding capacity: 150.68 l (TL-area)  
Dimensions (LxWxH): 650 x 658 x 702 mm  
**1,360.00 €**

**CARGO-UNIT STL L2 WITH DRAWER**  
Ref. No. 1000010320  
Colour: Black  
Material: Aluminium  
Weight: 29 kg  
Holding capacity: 150.68 l (TL-area)  
Dimensions (LxWxH): 650 x 658 x 702 mm  
**1,280.00 €**

**CARGO-UNIT STL L3 WITH 2 DRAWERS**  
Ref. No. 1000010369  
Colour: Black  
Material: Aluminium  
Weight: 40 kg  
Holding capacity: 208.30 l (TL-area)  
Dimensions (LxWxH): 888 x 658 x 712 mm  
**1,500.00 €**

**CARGO-UNIT STL L3 WITH DRAWER**  
Ref. No. 1000010321  
Colour: Black  
Material: Aluminium  
Weight: 35.5 kg  
Holding capacity: 208.30 l (TL-area)  
Dimensions (LxWxH): 888 x 658 x 712 mm  
**1,380.00 €**



**Stowage space and organisation in one saves you time, money and nerves.**

The SideTopLoader configuration of the Cargo-Unit has at the side rear a **lockable and splash water protected flap** into which you can optionally insert a **high Sortimo HD drawer or two flat drawers for tools and supplies**. The loading limit of the drawer amounts to 60 kg thanks to the **high-quality telescopic rails**.

## Basket-Unit

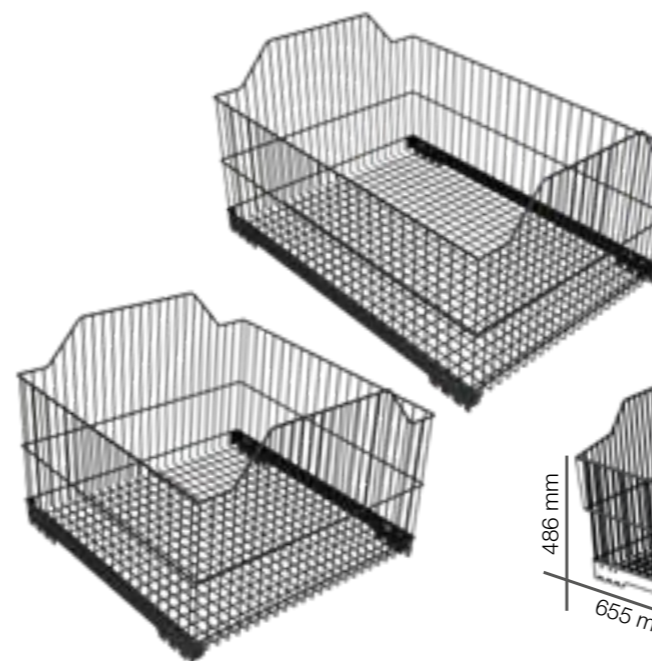

**BASKET-UNIT L2**  
Ref. No. 1000010496  
Colour: Black  
Material: Steel  
Weight: 7.8 kg  
Dimensions (LxWxH): 655 x 666 x 486 mm  
**235.00 €**

**BASKET-UNIT L3**  
Ref. No. 1000010497  
Colour: Black  
Material: Steel  
Weight: 9.8 kg  
Dimensions (LxWxH): 893 x 666 x 486 mm  
**245.00 €**

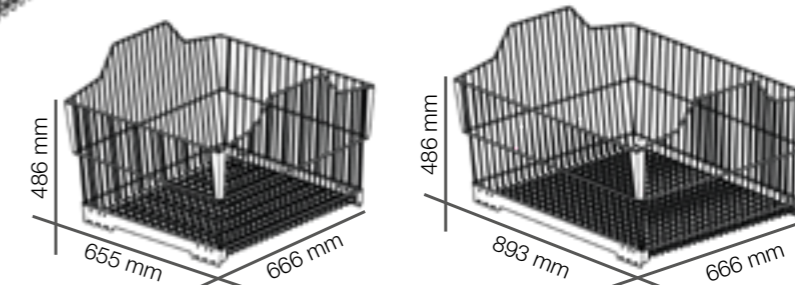

The Basket-Unit is the economically priced mobile add-on solution, which can be securely integrated into the ProSafe rail system on the ProCargo CT1 loading platform. **It can be quickly and simply installed and has a very low net weight**. The Basket-Unit is a practical and efficient transport system for the smaller budget, thanks to the useful accessories.

# ProCargo CT1

Comprehensive accessories for all circumstances

## Add-on systems accessories



### COVER BASKET-UNIT L2

Ref. No. 6000010407

The custom-made high-quality cover for the Basket-Unit L2, provides optimum protection in all weather conditions, it is water-proof and UV-resistant.

Colour: Blue

Material: PVC canvas cover

Dim. (LxWxH): 655 x 666 x 486 mm

**120.00 €**

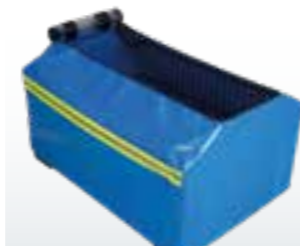

### COVER BASKET-UNIT L3

Ref. No. 6000010409

The custom-made high-quality cover for the Basket-Unit L3, provides optimum protection in all weather conditions, it is water-proof and UV-resistant.

Colour: Blue

Material: PVC canvas cover

Dim. (LxWxH): 893 x 666 x 486 mm

**130.00 €**



### DIVIDER BASKET-UNIT

Ref. No. 6000010370

The Basket-Unit can be divided into subsection enabling you to adapt your stowage space to meet your requirements.

Colour: Black

Material: Steel

Weight: 1.1 kg

Dim. (LxWxH): 368 x 679 x 14 mm

**35.00 €**



### WARNING LABELS SET FOR VEHICLES DIN 30710

Ref. No. 1000002178

Pre-configured warning labels set for vehicles according to the standard DIN 30710 minimum identification markings, simple to cut and attach. The label can be attached in a dry or wet state and is resistant even to a car wash and high pressure cleaning equipment.

**57.00 €**



### MULTIPACK TOOL RUCKSACK

Ref. No. 6000003567

Capacity: Higher compartment, nearest to your back: 11.69 l. Lower compartment on the outer part of the body: 7.51 l.

Max. loading capacity: 18 kg

Weight: 1.8 kg

Dim. (LxWxH): 230 x 360 x 500 mm

**152.80 €**



### FLUORESCENT RAIN COVER MULTIPACK

Ref. No. 6000003682

The rain cover is stowed away in a handy little bag and protects the MultiPack against rain when it is needed.

Weight: 0.07 kg

Dim. (LxWxH): 115 x 85 x 55 mm

**16.30 €**



### TOOL TRAY INSERT 3 RECESSES MULTIPACK

Ref. No. 6000003661

Tool tray made of deep-drawn hard plastic with 3 recesses for the MultiPack. The central compartment is designed to be able to accommodate a half Bosch-Inlay for the stowage of the cordless drill.

**7.70 €**



### ANTI-RATTLE MAT DRAWER

Protects the base of the drawer and its contents, prevents annoying noise generation.

Ref. No. 651003664 suitable for drawer 25-0

**6.50 €**

Ref. No. 651003665 suitable for drawer 35-0

**9.20 €**

## Load securing accessories



### LOAD SECURING NET

Simple and quick load securing

30 x 30 mm mesh size

Colour: blue, cord thickness 3.0 mm with a strengthened cord edge

Ref. No. 6000001114

Dim. (LxW): 800 x 1000 mm

weight : 0.55 kg

**39.10 €**

Ref. No. 6000001113

Dim. (LxW): 1000 x 1200 mm

Weight: 0.68 kg

**47.30 €**

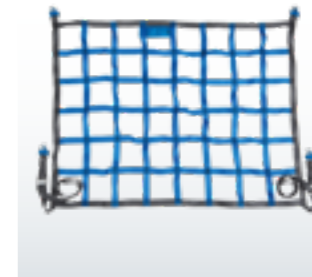

### PROSAFE LOAD SECURING NET

Particularly suitable for difficult to secure objects, bulky or round payloads, extremely sturdy and tear-proof.

Max. resilience: up to 400 daN

mesh size: approx. 100 mm

strap width: 25 mm

Ref. No. 1000004934

Dim. (LxW): 775 x 900 mm

**46.20 €**

Ref. No. 1000004935

Dim. (LxW): 775 x 1025 mm

**50.30 €**

A load securing net secures your valuable freight on the loading platform and is particularly suitable for the securing of objects which are difficult to secure, as in bulky or round payloads. We recommend the ProSafe load securing net especially for the commercial sector, as its quality and functionality has been tested and certified via the Dekra in accordance with the VDI guidelines 2700 part 3.3. Consequently you can rely on a long and functional usage of the ProSafe load securing net.



### PROSAFE LASHING STRAP CLAMP BUCKLE

Suitable for Sortimo ProSafe aluminium lashing rails, 100% polyester, max. loading : up to 225 daN.

Ref. No. 1000000224

strap length 1.4 m

**8.50 €**

Ref. No. 1000000222

strap length 3 m

**11.00 €**



### PROSAFE BUNGEE STRAP 1000 mm INCL. 2 HOOKS

Ref. No. 1000002455

Compatible with ProSafe aluminium lashing rails, for quick fixation of bulky loads to the left and right of the loading platform.

Colour: Anthracite

Weight: 0.13 kg

Length: 1 m

**9.00 € / Set**



### PROSAFE SCREW FITTING M8x20

Ref. No. 6000001006

Suitable for ProSafe aluminium lashing rails, for screwing on applications resilient up to 200 daN.

Colour: Silver

Weight: 0.01 kg

Dim. (LxWxH): 20 x 8 x 6 mm

**8.70 €**



### SINGLE LASHING POINT PROSAFE

Ref. No. 6000001231

Suitable for installation onto the loading platform, opens up a multitude of further lashing possibilities, resilience: 200 daN.

Colour: Silver

Weight: 0.06 kg

**2.50 €**



### ANTI-SLIP MAT UNIVERSAL 800x1200x4.5 mm

Ref. No. 6000003365

For professional load securing while transporting, sliding friction value  $\mu = 0.9$ , in addition it protects the loading platform.

Colour: Black

Weight: 2.02 kg

Dim. (LxWxH): 1200 x 800 x 4.5 mm

**48.20 €**



### FLEXIBLE EDGE PROTECTION FOR LASHING STRAPS 4 PCS.

Ref. No. 1000001870

Flexible edge protection bracket made of plastic, protects the payload and prevents the shifting of lashing straps, maximum strap with 35 mm.

Colour: Blue

Weight: 0.24 kg

Dim. (LxWxH): 180 x 75 x 7 mm

**13.30 €**

# ProCargo CT1

Comprehensive accessories for all circumstances

## Cargo cycle accessories

### POWERPACK 400 WH

Ref. No. 6000010392

Reliable and durable rechargeable battery without memory effect and self discharge.

Installation type: Battery attached to frame

Voltage: 36 V

Weight: 2.5 kg

Dim. (LxWxH): 325 x 92 x 90 mm

**759.00 €**

### POWERPACK 500 WH

Ref. No. 6000010393

Reliable and durable energy storage system without memory effect and self discharge, provides an ideal ratio on performance, size and weight.

Installation type: Battery attached to frame

Voltage: 36 V

Weight: 2.6 kg

Dim. (LxWxH): 325 x 92 x 90 mm

**859.00 €**

### STANDARD CHARGER

Ref. No. 6000010414

Sturdy and functional, enables extremely short-time charging cycles and operates soundlessly.

Charge current: max. 4 A

Voltage: 220 – 240 V

Weight: 0.8 kg

Dim. (LxWxH): 190 x 86 x 54 mm

**169.00 €**

### TELESCOPIC SEAT POST

Ref. No. 6000010396

Custom-fit stepless height adjustment of the saddle with a single hand movement, especially suitable for alternating drivers.

Length: 425 mm

Height adjustment: of approx. 110 mm

**109.00 €**

### NEOPRENE RECHARGEABLE BATTERY COVER

Ref. No. 6000010401

Preserves and protects the Bosch PowerPack against the cold and as a result enables a larger range and a longer service life.

Material: lined neoprene, 4.5 mm thick

Colour: Black

**39.00 €**

### TRAVEL CHARGER

Ref. No. 6000010395

Enables trouble free recharging in transit via the cigarette lighter socket or a 12 V socket, integrated discharge protection of the vehicle battery.

Charge current: max. 2 A

Voltage: 12 V

Weight: 0.5 kg

Dim. (LxWxH): 190 x 86 x 54 mm

**159.00 €**

### SUSPENSION SEAT POST

Ref. No. 6000010397

Suspension seat post with parallel-ogram mechanics made of forged aluminium, different spring rate (soft, medium, hard).

Length: 396 mm

Installation height: 150 mm

Driver's weight (max.): 115 kg

**209.00 €**

### ELECTRIC CAP

Ref. No. 6000010411

The elastic neoprene cap protects the connecting contacts against all kinds of weather conditions, freezing, dirt and damage when the battery is removed.

Material: lined neoprene, 4.5 mm thick

Colour: Black

Dim. (LxWxH): 11 x 8 x 5 mm

**19.00 €**

### SADDLE BAG

Ref. No. 6000010398

Installable quickly and simply, additional stowage possibilities for small components, carrier options: handle or an adjustable shoulder strap.

Capacity: 17.5 l

Weight: 0.74 kg

Dim. (WxHxD): 310 x 400 x 160 mm

**89.00 €**

### SMARTPHONE HOLDER

Ref. No. 6000010394

Enables the secure transport of mobile telephones, splash water protected casing in accordance with IPX4, non-reflective and scratch-proof foil at the front, incl. rubber inserts for height adjustment.

Weight: 0.32 kg

Dim. (LxWxH): 145 x 78 x 13.4 mm

**79.00 €**

### CANVAS COVER GARAGE

Custom-made high-quality, provides optimum protection in all weather conditions, it is water-proof and UV-resistant, securer and tighter fitting due to a circumferential draw-string cord and centrally sewn on fastening strap.

Colour: Blue

Material: Codura textile

Ref. No. 6000010402

Dim. canvas cover garage L2 (LxWxH): 2250 x 790 x 1000 mm

**150.00 €**

Ref. No. 6000010405

Dim. canvas cover garage L3 (LxWxH): 2790 x 790 x 1000 mm

**160.00 €**

### RAMP RAILS

Aluminium ramp rails with a protective edge, running surface with an anti-slip coating P13, inner lane width 150 mm, outer lane width 234 mm, protective edge height 30/42 mm.

Load bearing capacity 380 daN

Material: Aluminium

Ref. No. 801009243

Ramp rails fixed 2000

Weight: 16.0 kg

**402.50 €**

Ref. No. 801009245

Ramp rails fixed 2500

Weight: 20.0 kg

**507.50 €**



# ProCargo CT1

Comprehensive accessories for all circumstances

## Safety accessories



### HIGH VISIBILITY JACKET

Ref. No. 80720009

Protects you in the middle of dangerous road or factory traffic situations, simply and conveniently put it on over your normal clothing.

Complies with the requirements of the EN ISO 20471 and DIN 30711.

Colour: Orange

Weight: 0.12 kg

**3.90 €**



### WARNING TRIANGLE

Ref. No. 801009983

For securing areas where a breakdown or an accident has occurred, practical stowage case, complies with the EU directives.

Weight: 0.85 kg

Dim. (LxWxH): 435 x 60 x 35 mm

**17.90 €**



### L-BOXX MINI FIRST AID KIT DIN13164

Ref. No. 1000005024

Complies with the DIN 13164 standard for estate car first aid box, stackable by means of innovative click system, transparent cover.

Colour: Grey-White

Weight: 0.59 kg

Dim. (LxWxH): 260 x 155 x 63 mm

**16.70 €**



### L-BOXX MINI BREAKDOWN KIT

Ref. No. 1000010451

Content: Multitool SKS T-Worx, Mini-pump SKS Rookie XS, bicycle tube Schwalbe AV 19 27,5", bicycle tube Schwalbe AV 7 20", repair assortment Tip Top TT06.

Colour: Grey-White

Weight: 1.08 kg

Dim. (LxWxH): 260 x 155 x 63 mm

**103.00 €**



### SIGNAL TRAFFIC CONE, FOLDABLE 400 mm

Ref. No. 6000000082

Quickly removed and assembled in case of emergency, can be clearly seen from a distance and afterwards can be folded away for stowage in a space-saving manner.

Colour: Orange

Weight: 0.94 kg

Dim. (LxWxH): 250 x 250 x 55 mm

**41.60 €**



### WARNING LIGHT

Ref. No. 6000010391

16 extra bright LEDs (12x red / 4x white), water proof, impact and shock resistant 9 different warning functions with magnet and suspension lugs.

Colour: Orange

Height 45 mm, 115 mm ø

Weight: 0.21 kg

**35.00 €**

## Interested in more ProCargo CT1?

Have we sparked your interest and you wish to experience the new dimensions of transport and mobility yourself? Then **put the ProCargo CT1 to the test directly near you** and see for yourself, we look forward to meeting you!

You can access a current overview via **this QR-Code**, where you can check the availability of the next ProCargo CT1 for a test drive and **you can quickly and simply organise an appointment.**

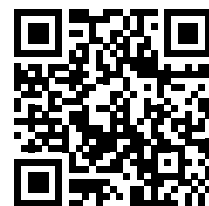

[mysortimo.com/cargo-bike](https://mysortimo.com/cargo-bike)

**Test drive now!**